

TCH140(358.4V40Ah)



Rack TCH140(S)
TCH140--without SBMS
TCH140(S)-- with SBMS



Module TCH20 -- 51.2V40Ah

Introduce

The TCSN TC series adopts high-safety LFP cells and features an intelligent BMS independently developed by TCSN. It is safe, reliable, and delivers excellent performance and stability, making it suitable for three-phase UPS backup systems.

The UPS series offers excellent compatibility and can be widely used in critical facilities such as data centers, financial institutions, rail transit, educational institutions, medical systems, large industrial and mining enterprises, and power grid systems, meeting the stringent requirements for power backup and power protection across various scenarios.

Features



Hassle-free & Long-lasting

Cycle life > 4000 cycles (1C, 80% DOD)
Design life: 20 years



Modular design

Simple combination
Quick installation



Multiple series and parallel

Ease of capacity expansion
Supports series and parallel connections



Integrated functions

Smart balancing good consistency
Multiple comms options



Flexible compatibility

Compatible with two-wire
three-wire systems



Visual design

Visual display interface
Easy maintenance

Performance

Performance Parameters	
Cell	Square LFP
Capacity(Ah)	40 Ah
Voltage(V)	358.4 V
Energy(Wh)	14.336 kWh
Rated Charge Current	20 A
Max. Charge Current	40 A
Rated Charge Voltage	380.8~386.4 V
Charge Cut-off Voltage	403.2 V
Balancing Voltage	>380.8 V
Max Output Power	140 KW
Standard Discharge Time	140 KW@5min
Rated Discharge Cut-off Voltage	313.6 V
Minimum Discharge Cut-off Voltage	296.8 V
Short-circuit Current	Approx.4000A

General Data	
Terminal	M8
IP Grade	IP21
Self-discharge	<=2%/Month
Cycle Life	4000 times(1C 80% DOD)
Weight	395 Kg
Dimensions	1000*600*1500mm
Storage Temperature	-5°C to 35°C
Discharge Temperature	-20°C to 65°C
Charge Temperature	0°C to 45°C

Size

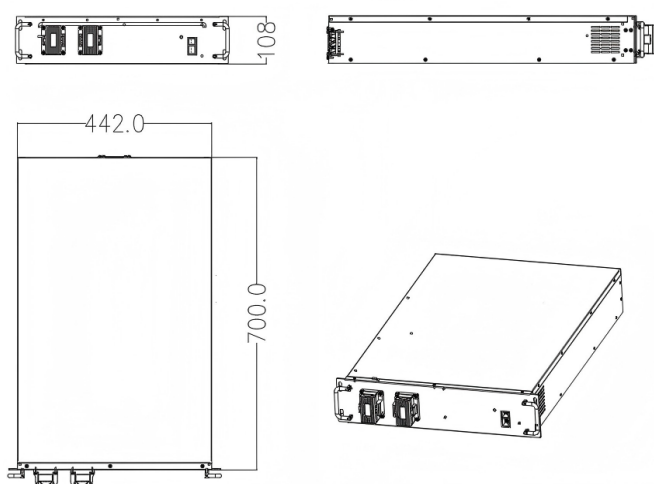

Compliance

Certifications	UN38.3/IEC62619(cell)
Transport Appraisal	UN3480,CLASS 9

Performance Data

Time(min)	5	10	15	20	30
Constant Power(kw)	140	78.4	53.3	40	27.6
Constant Current(A)	400	240	160	120	80

Characteristics Curve

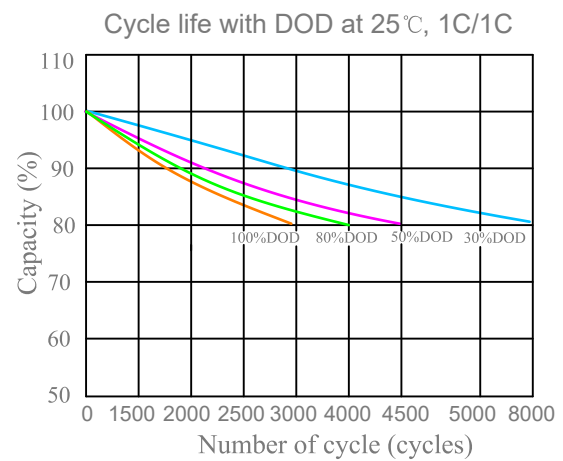
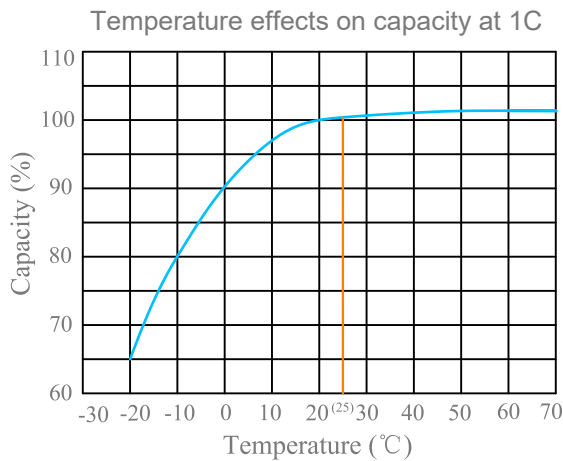
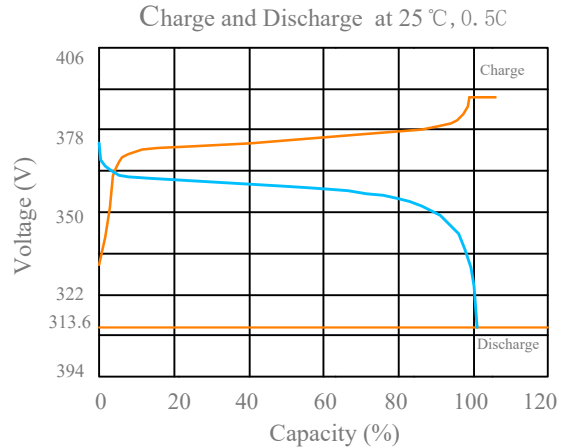
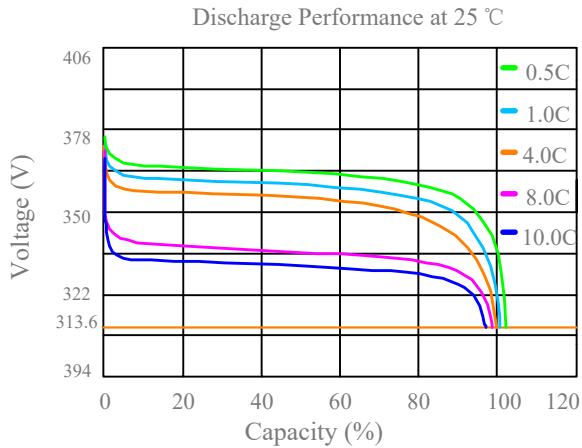

Cautions

1. Do NOT short circuit, crush or disassemble.
2. Do NOT heat or incinerate.
3. Do NOT immerse in any liquid.
4. Store at 50% capacity. Recharge every 6 months. The storage area should be clean, cool, dry and ventilated.
5. Disconnect charging source prior to connecting or disconnecting battery terminals.
6. Do NOT dispose of batteries in a fire as they can explode.
7. Do NOT open, alter, or mutilate batteries. Released electrolyte is harmful to skin and eyes. It may be toxic.
8. Do NOT mix different types and brands of lithium-ion batteries.
9. Do NOT dispose in trash, follow local regulations and manufacturer's instruction.
10. See installation instructions before connecting to the supply.
11. The battery cabinet receives power from more than one source. Disconnection of all DC sources is required to De-energize this unit before installing or servicing. Wait 5 minutes before opening the unit.
12. Do NOT install on or over combustible surfaces.
13. Refer to manual before servicing.
14. Do NOT touch bare terminals.